

# ELEVATOR TECHNOLOGY NORTH AMERICAN MARKET



**SIL<sup>3</sup>**  
READY

**SAFETY SOLUTIONS**  
**build the future**



## ABOUT US

**GIOVENZANA INTERNATIONAL B.V.** is one of the world's leading suppliers of **industrial safety technology**.

We study **tailor-made technical solutions** thanks to our design capability and production flexibility.

Our high quality products are designed, produced and assembled in our production warehouses in **Italy, Brazil and Hungary**.

We can guarantee to every customer the complete control of our **products' quality** able to satisfy the requirements of the current market.

Our main characteristics are a **strong international attitude** and the will to innovate and realize the demands of customers.

The wide variety of products offered, together with the knowledge of our research and development department, allow us to meet even the most specific and unusual situations.

Giovenzana International B.V. technical and commercial employees aim to provide complete support to our customers during the sales and aftersales processes.

**Quality, competence and safety solutions guided us in our daily work to develop the best products for all market needs.**

REV. 00\_21

**GIOVENZANA INTERNATIONAL B.V.**

reserves all the rights to modify, as specifications change, all technical and functional characteristics of the products shown in this catalogue without prior notice as this information is intended for general knowledge and is not legally binding.

All the images contained in this catalog are purely for explanatory purposes.

The most up-to-date version of this catalogue can be downloaded from the download section of the website:

[www.giovenzana.com](http://www.giovenzana.com)

## PRODUCT CATEGORIES

To easily consult this catalog, it is divided by the positioning of the product lifts. Here are the product categories and the symbols that will guide you in the catalogue.

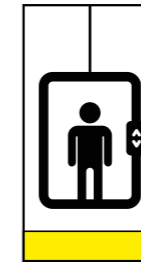

**PIT BOTTOM**  
controls



**ACCESSORIES**  
complementary products



**CAR TOP**  
inspection boxes

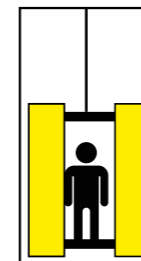

**DOOR**  
components



**PANEL BOARD**  
components

## ASME A17.1/CSA B44: Safety Code for Elevators and Escalators



The safety code for elevators and escalators, **ASME A17.1-2019**, or, if you're in Canada, **CSA B44-2019**, has been revised.

**ASME A17.1/CSA B44-2019:** Safety Code For Elevators And Escalators serves as a basis for the design, construction, installation, operation, testing, inspection, maintenance, alteration, and repair of elevators, dumbwaiters, escalators, moving walks, and material lifts.

### The Safety Code for Elevators

Enhancing skywards construction by permitting taller buildings, elevators fortify the modern life in which we thrive. In all, U.S. elevators make 18 billion passenger trips each year. **ASME A17.1-2019**, as a code, is intended to provide safety of life and limb and promote public welfare. It covers not only elevators, escalators, moving walks, dumbwaiters, material lifts, and related equipment, but also their associated parts, rooms, spaces, and hoistways. The **ASME A17.1-2019** document is broken up into specific parts to ease compliance. Each part, other than those detailing general requirements, cover a specific equipment—electric elevators, hydraulic elevators, elevators with other types of driving machines, special application elevators, escalators and moving walks, and dumbwaiters and material lifts.

### Changes to ASME A17.1-2019/CSA B44-2019

The safety code for elevators dates back just about one century, so, over the years, numerous revisions have kept it current. With these changes, the scope of the document has expanded, accommodating not just elevators but also escalators, dumbwaiters, and other equipment types. Decades of changes have developed **ASME A17.1-2019** into an expansive and hefty document, comprehensively approaching various topics pertinent to elevators and other machinery in its over 500 pages of content.

A17.1 has been harmonized with CSA B44 to provide one comprehensive solution for jurisdictions throughout North America.

Important changes to this standard include:

- Updates to door requirements in private residence elevators and occupant evacuation elevators.
- Seismic requirements for elevators and escalators were clarified.
- Updates were made to emergency communication requirements for an elevator to ensure communication with any trapped passengers, including those who are hearing impaired.
- Requirements were modified for increased door protection on passenger elevators.

**GIOVENZANA®**, an innovator in elevator products for over 65 years, has been successful in providing solutions to every major elevator manufacturer in the world.

In fact, when it comes to products like car top inspection boxes, temporary run stations, pit bottom control stations, emergency stop control stations, recall drive control units and custom products the leading elevator companies in the world rely on Giovenzana International.

Over the years we have lead the way with product designs, product quality and reliability and international safety standards.

The Giovenzana Elevator Products are used to facilitate inspection and maintenance whether on the car roof, in the pit, in the car or on a platform.



**We have worked closely with approvals and standards organizations to develop standards and guidelines for increased safety including UL, CSA, IMQ, CCC, RINA, EAC and others.**



## PIT STOP SWITCHES

IP65

When you need a convenient, safe and reliable way to provide emergency stop to your service technicians you can count on Giovanzana elevator products.



DESCRIPTION	SCHEME	CONTACTS	CODE
Emergency stop EN ISO 13850 PPFN1P4S ø40 push-pull with visual indicator		1NO + 1NC (PL004001 + PL004002)	<b>SLA11NPNC001</b>
		1NO-1NC-1NO (PCW010SS)	<b>SLA11NPNC001-SS</b>

DESCRIPTION	SCHEME	CONTACTS	CODE
Emergency stop EN ISO 13850 PPFN1PASH ø40 push-pull with visual indicator		1NC (PL004001)	<b>SLA11NPNC002</b>
		1NO-1NC-1NO (PCW010SS)	<b>SLA11NPNC002-SS</b>

DESCRIPTION	SCHEME	CONTACTS	CODE
Emergency stop EN ISO 13850 PPFN1PASH ø40 push-pull with visual indicator		1NC (PL004001)	<b>SLA11NPNCGMS360</b>

DESCRIPTION	SCHEME	CONTACTS	CODE
Emergency stop EN ISO 13850 PPFN1PASH ø40 push-pull with visual indicator		1NC (PCW01)	<b>SLA11NPNCGMS122</b>

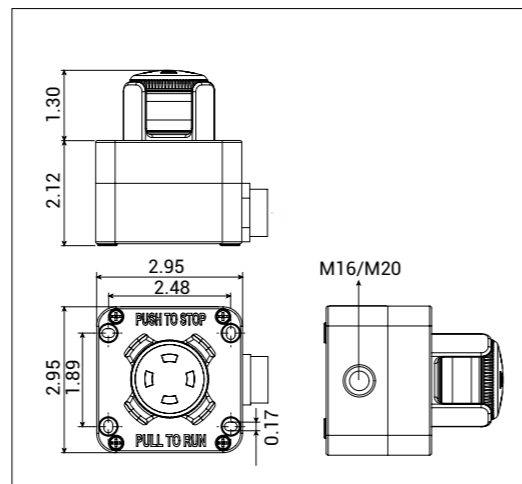
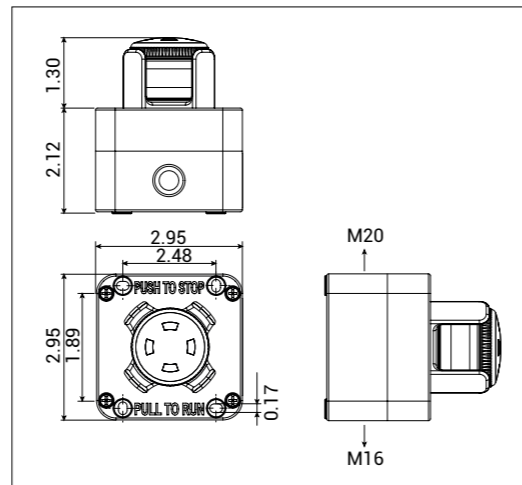
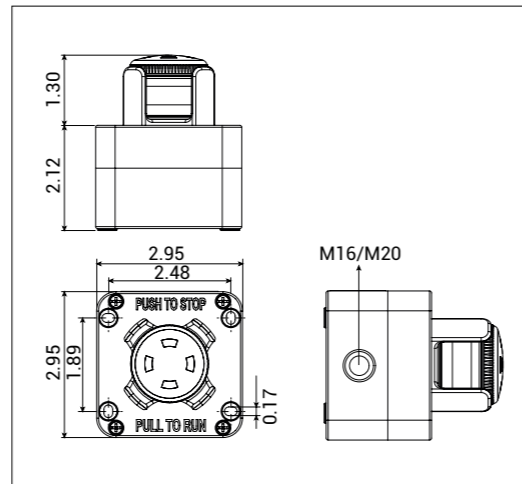

## PIT STOP AND ALARM SWITCHES

IP65

DESCRIPTION	SCHEME	CONTACTS	CODE
Emergency stop EN ISO 13850 ø40 push-pull		1NC	<b>TLP1.EPP</b>



DESCRIPTION	SCHEME	CONTACTS	CODE
Emergency stop EN ISO 13850 ø40 push-pull with vision		1NC	<b>TLP1.VPP</b>



DESCRIPTION	SCHEME	CONTACTS	CODE
Emergency stop EN ISO 13850 ø40 twist to release		1NC	<b>TLP1.ESR</b>



DESCRIPTION	SCHEME	CONTACTS	CODE
ALARM Mushroom Button ø40, flush, momentary, yellow colour		1NO	<b>TLP1B.AL</b>

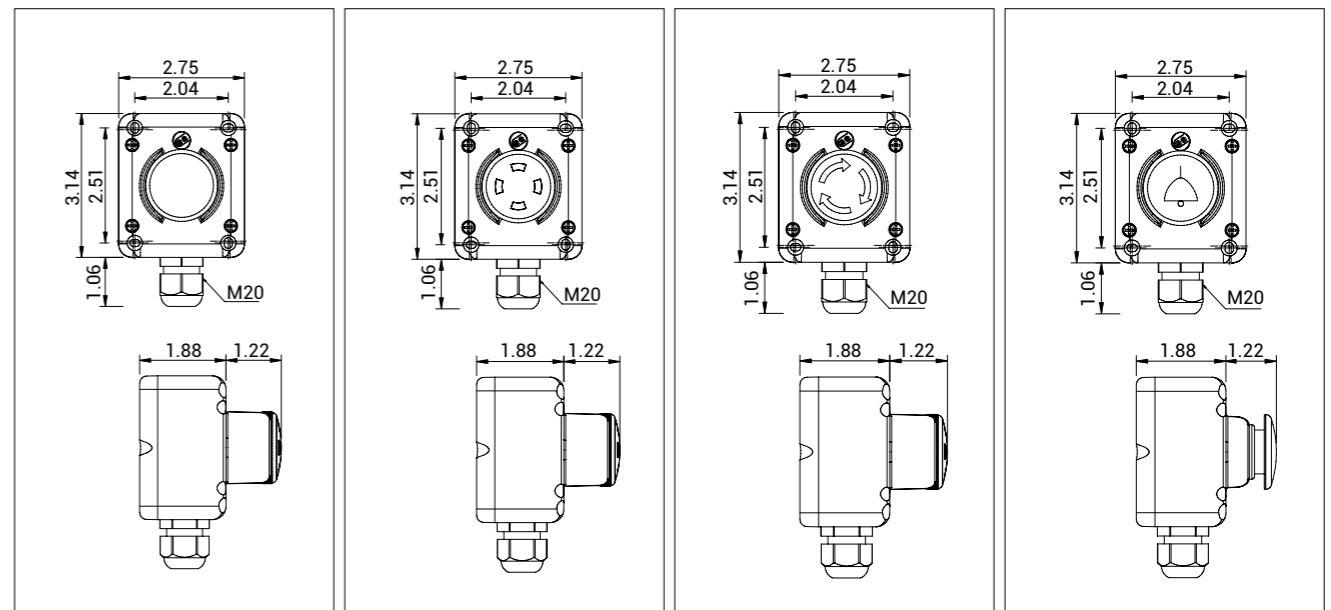

NOTE: Dimensions of technical drawings are in inches



PIT SWITCHES

**COMPLEMENTARY PRODUCTS**

DESCRIPTION	CODE
Adaptor M16 - 1/2 NPT <i>In brass material - nickel treatment</i>	<b>12903020</b>
Adaptor M20 - 1/2 NPT <i>In brass material - nickel treatment</i>	<b>12903028</b>



DESCRIPTION	CODE
Self-monitored contact NO-NC-NO	<b>PCW010SS</b>

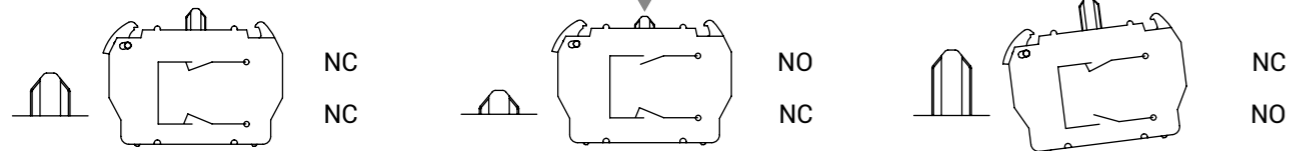

NOT ACTIVATED CONTACT

ACTIVATED CONTACT

DETACHED CONTACT (ACTIVATED)

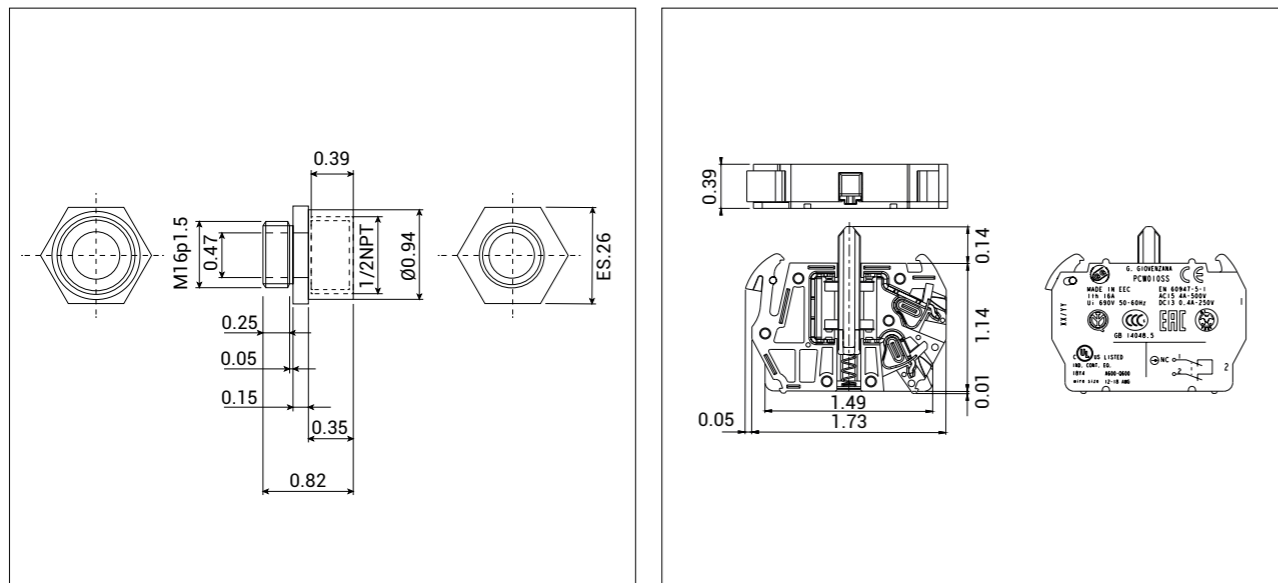

PCW010SS are open-type contact blocks, normally-closed (NC), spring terminals, with contacts intended and suitable for use with push buttons. A specific adapter mechanically connects the button to the contact block actuator.

The PCW010SS self-monitoring contact block offers additional safety in emergency stop applications.

This device contains an additional normally open contact that uses a unique actuator to monitor whether the contact block is still attached to the operator.

In the event of the contact block becoming detached from the emergency stop button, the self-monitoring contact block opens the circuit and stops the system, providing an extra safety measure.

**GENERAL CHARACTERISTICS**

Material - Colour		PA66 H2 G/25-V0 - YELLOW/BLACK AgNi 10 Ø 0.03 inch							
Protection class	EN 60529	IP20							
Standards		IEC / EN60947-5-1 - UL508 - UL486E - UL1059							
Temperature	operating storage	-25°C ... +70°C -30°C ... +70°C							
Rated insulation voltage	Ui	690 V							
Rated impulse withstand voltage	Uimp	4 kV (UL508: A600 - Q600)							
Frequency		50/60 Hz							
Rated thermal current	Ith	16 A							
AC-15 alternate current	Ue [V]	24	60	110	250	400	440	500	690
	Ie [A]	10	6	6	6	4	4	4	1
DC-13 direct current	Ue [V]	12	24	48	110	250			
	Ie [A]	2	2	2	0.4	0.4			
DC-14 direct current	Ue [V]	12							
	Ie [A]	10							
Positive operation		NC contact block ⊕							
Terminals type		spring contacts(wire peeling length: 0.31 inch)							
Terminals caliber		A2							
Terminals capacity		1 or 2 flexible and solid conductor1...							
		0.003 inch <sup>2</sup> / 12-20 AWG							
Mechanical life	min	1.000.000 of cycles							



















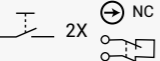

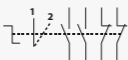
**IP20**









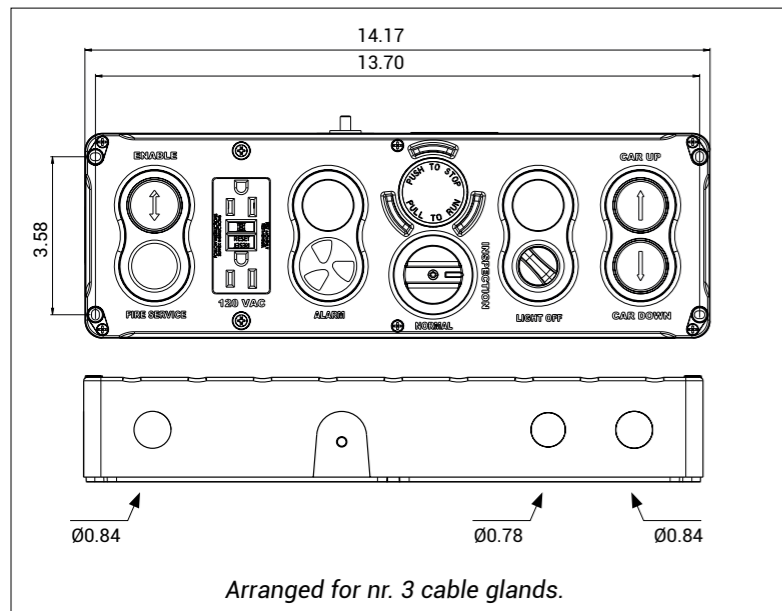







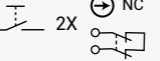

## CAR TOP INSPECTION BOXES

IP54

We offer a wide range of standard car top inspection boxes and based on your requirements are available for custom configurations. Give us a call to see the wide range of inspection boxes now available!

DESCRIPTION	SCHEME	CONTACTS	CODE 1	CODE 2
 <b>COMMON Push Button</b> flush, momentary, blue colour		1NO		
 <b>Fire Service Red LED PILOT LIGHT</b> red colour	 AC/DC 24V			
 <b>GFCI socket 15 A - 125 V</b>				
 <b>Stopping closing holes</b> black colour			<b>GMS305</b>	<b>GMS354</b>
 <b>BUZZER</b>			with <b>BUZZER</b> 30 - 120 V	with <b>BUZZER</b> 6 - 28 V
 <b>Emergency stop EN ISO 13850</b> ø40 "push to stop/pull to run"	 2X  NC	2 × PCW010SS + 1NO	Min 80dB @ 60 CM / 12 V DC	Min 80dB @ 60 CM / 120 V DC / V AC
 <b>Cam Switch 0-1 Normal-Inspection</b> 90° switching		2NO+2NC		
 <b>Stopping closing holes</b> black colour				
 <b>Knob Selector 0-1</b> 2 positions, white indicator	OFF 0 ON 	1NO		
 <b>UP Push Button</b> flush, momentary, white colour		1NO		
 <b>DOWN Push Button</b> flush, momentary, black colour		1NO		





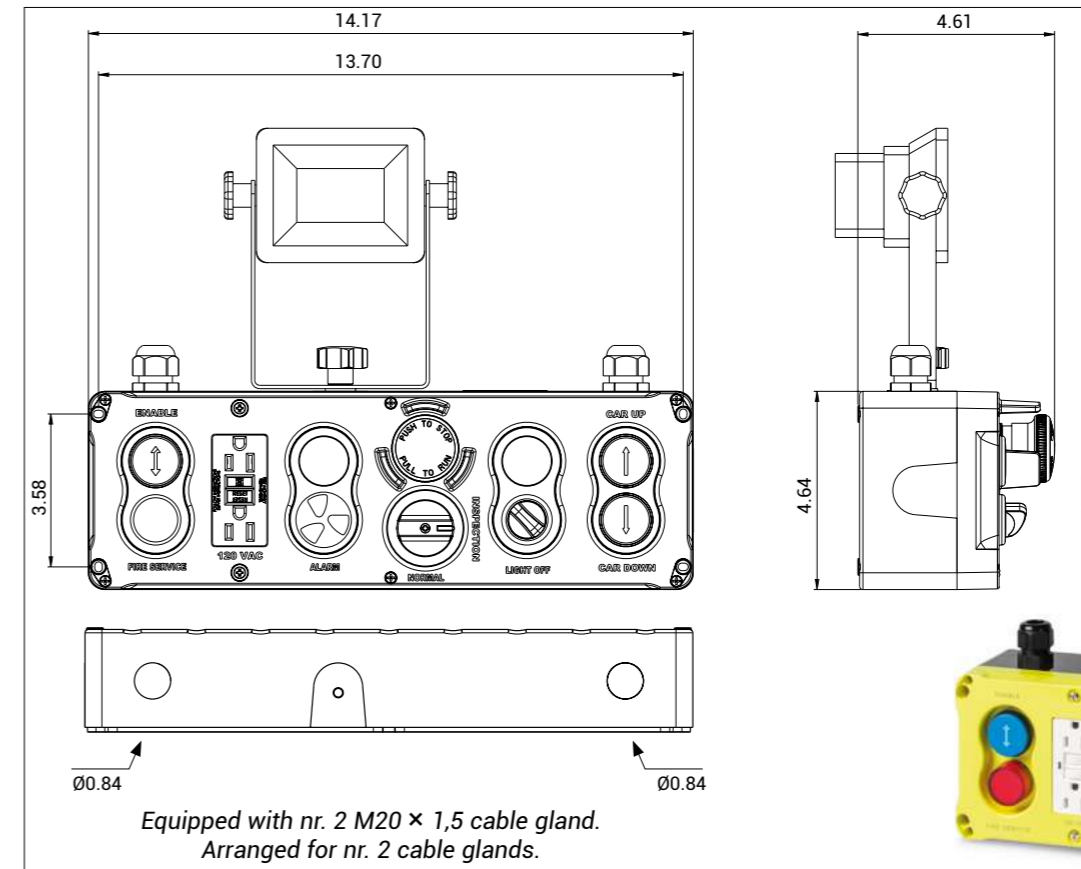



DESCRIPTION	SCHEME	CONTACTS	CODE 1	CODE 2
<b>LED LAMP</b> 12W 1000 LUMEN 120V				
 <b>COMMON Push Button</b> flush, momentary, blue colour		1NO		
 <b>Fire Service Red LED PILOT LIGHT</b> red colour	 AC/DC 24V			
 <b>GFCI socket 15 A - 125 V</b>				
 <b>Stopping closing holes</b> black colour			<b>GMS312</b>	<b>GMS355</b>
 <b>BUZZER</b>			with <b>BUZZER</b> 30 - 120 V	with <b>BUZZER</b> 6 - 28 V
 <b>Emergency stop EN ISO 13850</b> ø40 "push to stop/pull to run"	 2X  NC	2 × PCW010SS + 1NO	Min 80dB @ 60 CM / 12 V DC	Min 80dB @ 60CM / 120 V DC / V AC
 <b>Cam Switch 0-1 Normal-Inspection</b> 90° switching		2NO+2NC		
 <b>Stopping closing holes</b> black colour				
 <b>Knob Selector 0-1</b> 2 positions, white indicator	OFF 0 ON 	1NO		
 <b>UP Push Button</b> flush, momentary, white colour		1NO		
 <b>DOWN Push Button</b> flush, momentary, black colour		1NO		



## TEMPORARY RUN STATION

IP54

Temporary Run Station with Tubular Key Lock, 5 Position includes E-stop and Up / Down Push Buttons.

DESCRIPTION	SCHEME	CONTACTS	CODE
 <b>COMMON Push Button</b> flush, momentary, green colour		1NO+1NC	<b>PL05.MT</b>
 <b>Key Selector 0-1 90°</b> Key removal 0-1		1NO	
 <b>Emergency stop EN ISO 13850</b> ø30 twist to release with vision		2NC	
 <b>UP Push Button</b> flush, momentary, white colour		1NO+1NC	
 <b>DOWN Push Button</b> flush, momentary, black colour		1NO+1NC	

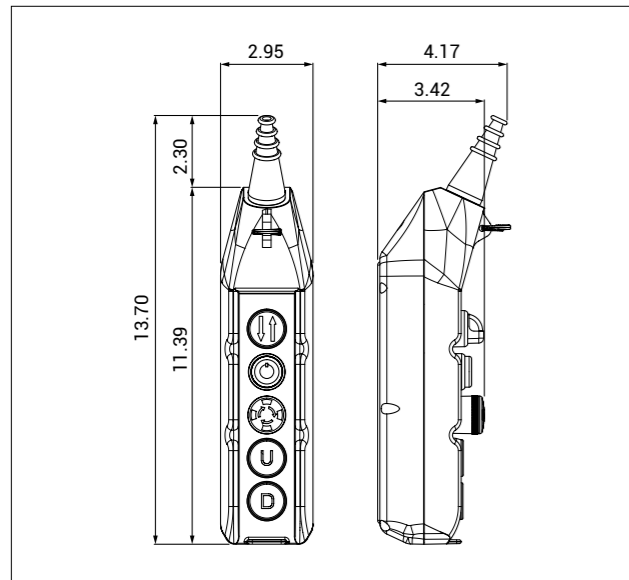

- Robust temporary run station, ideal for elevator testing
- Tubular key lock with two keys, used to engage operation
- Easy to operate push buttons with engraved arrow symbol and letters

## ESCAPE HATCH SAFETY SWITCHES

IP65



The **STNK series of safety interlock and safety door switches** is a line of specially designed safety switches for machine door and guard applications. This tongue or key operated safety interlock switch is cUL508 Listed, available with positive opening NC contacts and carries an IP65, NEMA 4, 4X, 6 and 6P protection rating.

Customer wiring to this safety interlock switch is simplified due to the removable contact blocks. The head of this safety door switch can be mounted in 4 directions and the key or tongue can be inserted into the safety switch in 5 directions including downwards.

Applications for the STNK series include safety gate switch, door interlock switch, guard safety switch and as a panel door safety switch. The housing of these mechanical safety interlock switches are double insulated avoiding the need for additional ground connections.

The **STNK02 Series** of safety interlock switch and safety door switch models **with a flat key** are safety switches for machine and equipment applications that require a robust safety limit switch.

The STNK02 safety interlock switch can be ordered with different contact types including 2NC/1NO slow action and 1NC/1NO snap action.

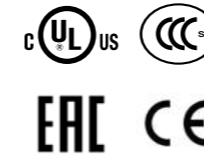

### TECHNICAL DATA

Standards		EN 60947-5-1, UL 508, EN 50047, EN 1088, EN 60204-1
Approvals		cULus, EAC, CCC and CE marked for all applicable directives
Positive opening operation		NC contacts conforming to IEC /EN 60947-5-1
Minimum current		5 mA - 5 V DC
Thermal current	I <sub>th</sub>	10 A
Rated insulation voltage	U <sub>i</sub>	500 V AC
Rated impulse withstand voltage	U <sub>imp</sub>	6 kV
Insulation resistance	min	100 MΩ (DC 500 V)
Contact resistance	max	25 mΩ (initial)
Actuator frequency	max	2 cycles/min
Enclosure material		UL approved glass-filled polybutylene terephthalate
Enclosure protection		IP65
Operating temperature		-25 ... +80°C (-13 ... +176°F)
Pollution degree		3
Protection against electric shock		Class II (double Insulation) Double insulation makes ground terminal unnecessary
Electrical life expectancy	min	150.000 cycles
Mechanical life expectancy	min	1 x 10 <sup>6</sup> cycles
Vibration	IEC 68-2-6 excursion	10-55 Hz ± 1Hz 0.35 mm, 1 octave/min
Conduit entry		1/2" NPT
Fixing		2 x M4 screws

**STNK02**

Thermoplastic safety switch with straight actuator  
IP65

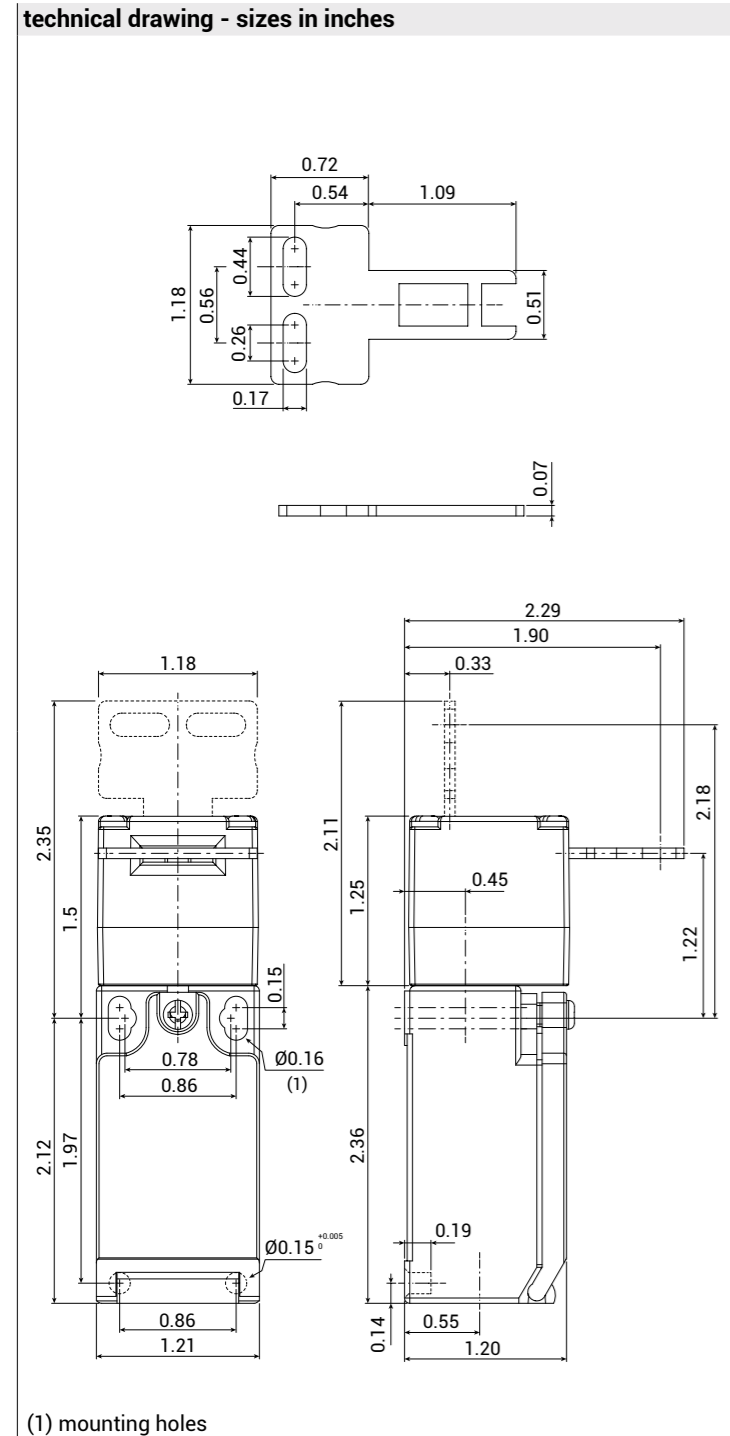

(1) mounting holes

contact type	categories	ratings	operational travel		operating force	positive opening		total travel
			PT1	PT2 (slow action) RP (snap action)		POT (travel)	POF (force)	
Z11: 1NO+1NC snap action (Zb)	B600-Q600	AC15: 400V - 4A	6.5 mm	4.8 mm	14 N	8.0 mm	26 N	∞
W12: 1NO+2NC slow action (Zb)	A300-Q300	DC13: 24V - 6A	7.2 mm	8.0 mm	25 N	8.2 mm	60 N	

**STNK02**

Thermoplastic safety switch with straight actuator  
IP65



STNK series	02 actuator	XXX contact type	XX conduit entry
STNK thermoplastic safety switch	02 with straight actuator	Z11: 1NO+1NC snap action (Zb) W12: 1NO+2NC slow action (Zb)	N 1/2" NPT

contact type	operation diagrams
Z11 1NO+1NC snap action (Zb)	
W12 1NO+2NC slow action (Zb)	

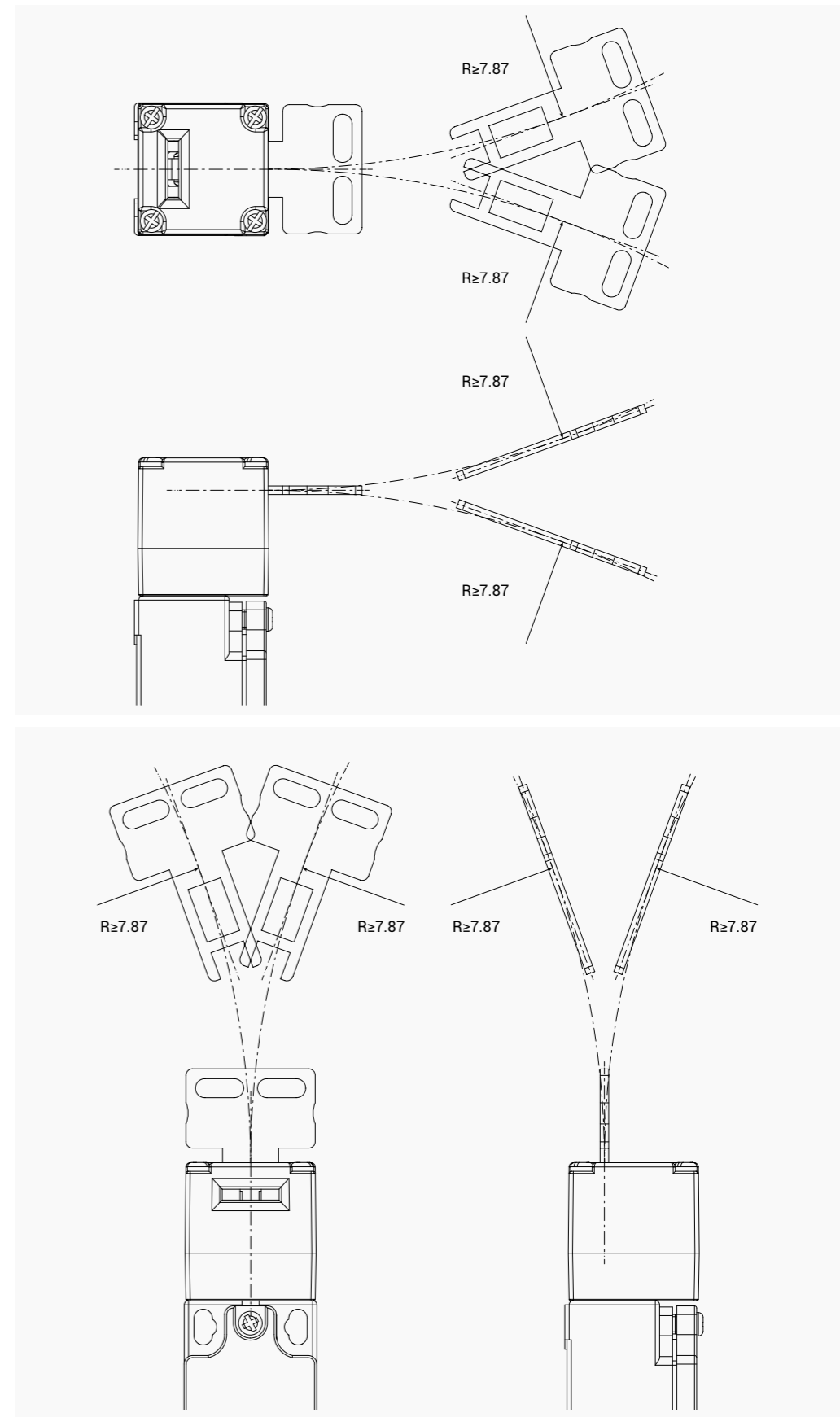
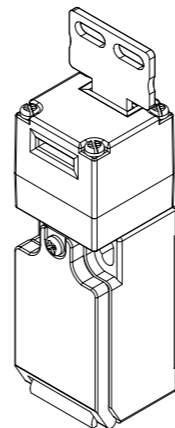
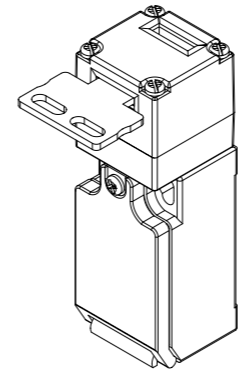

NOTE: Dimensions of technical drawings are in inches



**THERMOPLASTIC LIMIT SWITCHES**

**IP67** 

The thermoplastic limit switches of the **FTN series** comply with EN 50047 and are designed to provide a wide range of switch variants (slow action or snap action basic switches) and a variety of actuating heads and levers suitable also for safety applications.

The thermoplastic bodies have two fixing holes with distance of 20 or 22 mm and one hole for cable entry on the bottom of the switch.

Various types of threaded cable entry are available to cover the main requirements of the international market.

The maximum product versatility is guaranteed by the adjustable actuators in 90° steps, allowing easy mounting and lever adjustment every 18° for 360°.

They can be used in applications other than protective doors, e.g. on moving machinery benches, crane arms, hoists, elevators, etc...

They are also suitable for use in the harshest environmental conditions with an **operating temperature range of -25°C to +80°C**.

All models in the series are **IP67 rated**.

The actuators are made of metal or thermoplastic material, while the housing is made of thermoplastic glass-filled polybutylene terephthalate.

Giovenzana limit switches offer solutions for every need and are suitable for the most varied sectors of use.



TECHNICAL DATA		
Standards		EN 60947-5-1, UL 508, EN 50047, EN 1088, EN 60204-1
Approvals		cULus, CCC, EAC and CE marked for all applicable directives
Positive opening operation		NC contact conforming to IEC /EN 60947-5-1
Minimum current		5 mA - 5 V DC
Thermal current	I <sub>th</sub>	10 A
Rated insulation voltage	U <sub>i</sub>	500 V
Rated impulse withstand voltage	U <sub>imp</sub>	6 kV
Insulation resistance	min	100 MΩ (DC 500 V)
Contact resistance	max	25 mΩ (initial)
Switching speed	max	250 mm/s
Switching frequency	max	6000 operations per hour
Enclosure material		UL approved glass-filled polybutylene terephthalate
Enclosure protection		IP67 (all models except for code FTN146 which is IP65 rated)
Operating temperature		-25 ... +80°C (-13 ... +176°F)
Pollution degree		3
Protection against electric shock		Class II (double Insulation)
Electrical life expectancy	min	150.000 cycles
Mechanical life expectancy	min	1 × 10 <sup>7</sup> cycles
Vibration	IEC 68-2-6 excursion	10 - 55 Hz ± 1Hz 0.35 mm, 1 octave/min
Conduit entry		Various international conduit sizes
Fixing		2 × M4 screws

**FTN144**

Limit switch with Ø18 PA roller lever with variable length  
**IP67**



FTN series	1 function	44 actuator	XXX contact type	XX conduit entry
FTN thermoplastic limit switch	1 without reset function	44 Ø18 PA roller lever with variable length	X11: 1NO+1NC W02: 2NC Z11: 1NO+1NC Z02: 2NC W12: 1NO+2NC W03: 3NC	blank M N G1 G3 C
			slow action (Zb)	M16 × 1.5 (standard) M20 × 1.5 1/2" NPT PG11 PG13.5 male code "A" M12 × 1 connector
			slow action (Zb)	
			slow action (Zb)	

technical drawing - sizes in inches

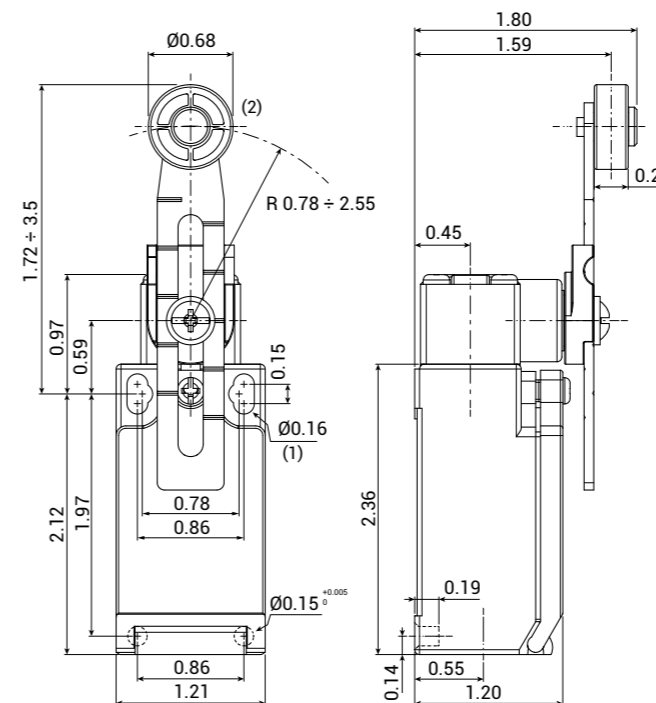

(1) mounting holes  
(2) PA roller

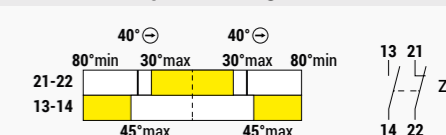
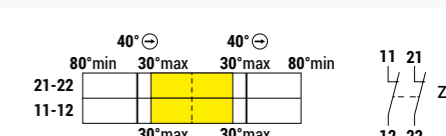
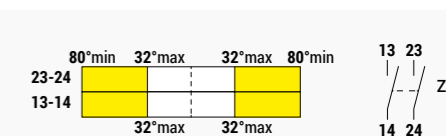
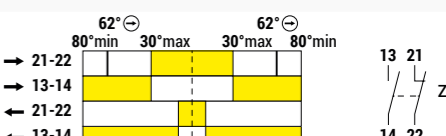
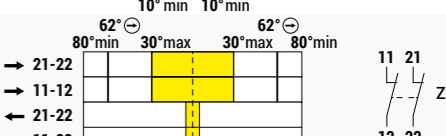
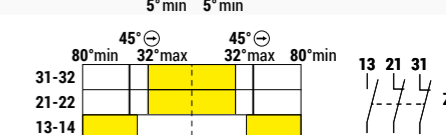
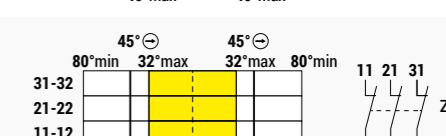
contact type	operation diagrams
X11 1NO+1NC slow action (Zb)	
W02 2NC slow action (Zb)	
W20 2NO slow action (Zb)	
Z11 1NO+1NC snap action (Zb)	
Z02 2NC snap action (Zb)	
W12 1NO+2NC slow action (Zb)	
W03 3NC slow action (Zb)	

contact type	categories	ratings	operational travel		operating force OF	positive opening		total travel TT
			PT1	PT2 (slow action) RP (snap action)		POT (travel)	POF (force)	
X11: 1NO+1NC	A600-Q600	AC15: 400V - 4A	30°	45°	6.5 N	40°	6 N	80°
W02: 2NC			30°	-	6.5 N	40°	6 N	
W20: 2NO			32°	-	6.5 N	-	-	
Z11: 1NO+1NC	B600-Q600	DC13: 24V - 6A	30°	10°	2.1 N	62°	5.5 N	80°
Z02: 2NC			30°	5°	2.1 N	62°	5.5 N	
W12: 1NO+2NC			32°	40°	6.5 N	45°	5.4 N	
W03: 3NC	A300-Q300		32°	-	6.5 N	45°	5.4 N	



**FTN144S**

Limit switch with Ø18 PA roller lever with variable sawtooth length (step: 2.2 mm)  
IP67



FTN series		1 function	44S actuator	XXX contact type	XX conduit entry
FTN	thermoplastic limit switch	1 without reset function	44S Ø18 PA roller lever with variable sawtooth length (step: 2.2 mm)	X11: 1NO+1NC W02: 2NC W20: 2NO Z11: 1NO+1NC Z02: 2NC W12: 1NO+2NC W03: 3NC	blank M16 × 1.5 (standard) M M20 × 1.5 N 1/2" NPT G1 PG11 G3 PG13.5 C male code "A" M12 × 1 connector

technical drawing - sizes in inches

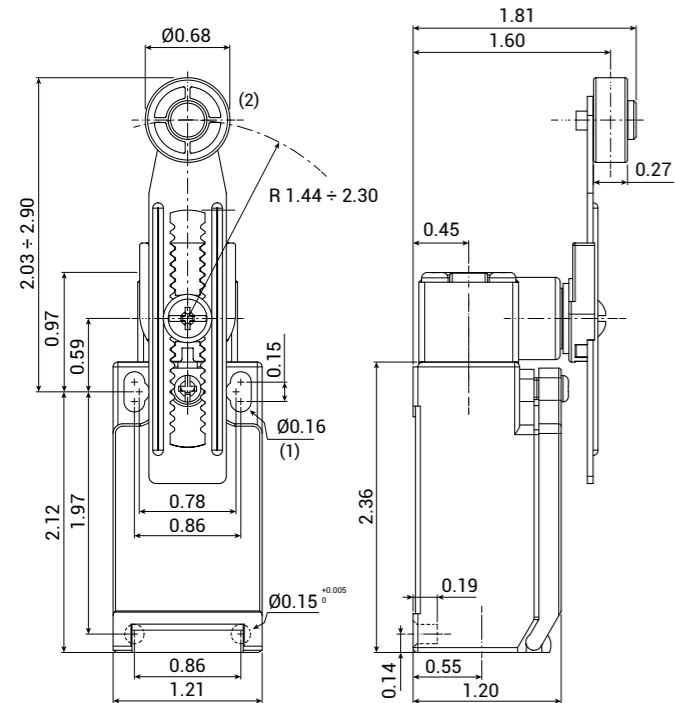

(1) mounting holes  
(2) PA roller

contact type	categories	ratings	operational travel		operating force OF	positive opening		total travel TT
			PT1	PT2 (slow action) RP (snap action)		POT (travel)	POF (force)	
X11: 1NO+1NC W02: 2NC W20: 2NO	slow action (Zb) A600-Q600	AC15: 400V - 4A	30°	45°	6.5 N	40°	6 N	80°
Z11: 1NO+1NC Z02: 2NC	snap action (Zb) B600-Q600	DC13: 24V - 6A	30°	10°	2.1 N	62°	5.5 N	
W12: 1NO+2NC W03: 3NC	slow action (Zb) A300-Q300		30°	5°	2.1 N	62°	5.5 N	
			32°	40°	6.5 N	45°	5.4 N	
			32°	-	6.5 N	45°	5.4 N	
			32°	-	6.5 N	45°	5.4 N	

**40MM THERMOPLASTIC LIMIT SWITCHES FOR HEAVY APPLICATIONS IP67**

The 40 mm FTNG series of thermoplastic limit switches complies with EN 50041 and is designed to provide a wide range of switch variants (slow action or snap action basic switches) and a variety of actuating heads and levers suitable also for safety applications.

The thermoplastic bodies have four fixing holes at a distance of 30 × 60 mm and a hole for the cable input/output at the bottom of the switch.

The maximum product versatility is guaranteed by the adjustable actuators in 90° steps, allowing easy mounting and lever adjustment every 18° for 360°.

They are particularly suitable for heavy applications, thanks to their solidity of steel parts, head and lid fixed by threaded inserts and metric screws. The fixing is prepared for 4 M5 screws.

They are also suitable for use in the harshest environmental conditions with an operating temperature range of -25°C to +80°C.

All models in the series are IP67 rated.

The actuators are made of metal or thermoplastic material, while the case is made of thermoplastic glass-filled polybutylene terephthalate.

Giovanzana limit switches offer solutions for every need and are suitable for the most varied sectors of use.



**TECHNICAL DATA**

Standards		EN 60947-5-1, UL 508, EN 50041, EN 1088, EN 60204-1
Approvals		cULus, EAC, CCC and CE marked for all applicable directives
Positive opening operation		NC contacts conforming to IEC /EN 60947-5-1
Minimum current		5 mA - 5 V DC
Thermal current	Ith	10 A
Rated insulation voltage	Ui	500 V
Rated impulse withstand voltage	Uimp	6 kV
Insulation resistance	min	100 MΩ (DC 500 V)
Contact resistance	max	25 mΩ (initial)
Switching speed	max	250 mm/s
Switching frequency	max	6000 operations per hour
Enclosure material		UL approved glass-filled polybutylene terephthalate
Enclosure protection		IP67
Operating temperature		-25 ... +80°C (-13 ... +176°F)
Pollution degree		3
Protection against electric shock		Class II (double Insulation) Double insulation makes ground terminal unnecessary
Electrical life expectancy	min	150.000 cycles
Mechanical life expectancy	min	1 × 10 <sup>7</sup> cycles
	IEC 68-2-6 excursion	10-55 Hz ± 1Hz 0.35 mm, 1 octave/min
Vibration		
Conduit entry		Various international conduit sizes
Fixing		4 × M5 screws

### FTNG131

Limit switch with short metal end plunger  
IP67



FTNG series	1 function	31 actuator	XXX contact type	XX conduit entry
FTNG 40 mm thermoplastic limit switches for heavy applications	1 without reset function	31 short metal end plunger	X11: 1NO+1NC W02: 2NC W20: 2NO Z11: 1NO+1NC Z02: 2NC W12: 1NO+2NC W03: 3NC	blank M20 x 1.5 (standard) N 1/2" NPT G3 PG13.5 C male code "A" M12 x 1 connector

technical drawing - sizes in inches

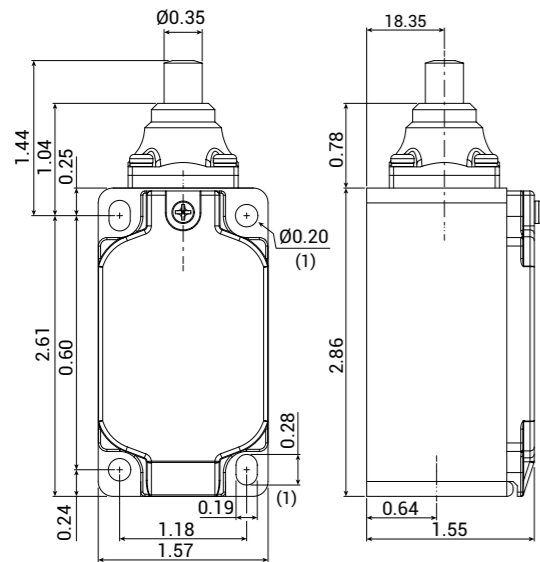

(1) mounting holes

contact type	categories	ratings	operational travel		operating force OF	positive opening		total travel TT
			PT1	PT2 (slow action) RP (snap action)		POT (travel)	POF (force)	
X11: 1NO+1NC W02: 2NC W20: 2NO	A600-Q600	AC15: 400V - 4A	2.6 mm	3.8 mm	11.6 N	6.0 mm	28 N	7.0 mm
Z11: 1NO+1NC Z02: 2NC	B600-Q600	DC13: 24V - 6A	2.6 mm	-	11.6 N	6.0 mm	28 N	
W12: 1NO+2NC W03: 3NC	A300-Q300		2.6 mm	-	11.4 N	-	-	
			2.5 mm	1.2 mm	10.4 N	4.9 mm	22 N	
			2.5 mm	1.2 mm	8.6 N	4.9 mm	22 N	
			2.8 mm	3.5 mm	9.4 N	5.0 mm	10 N	

### FTNG139

Limit switch with Ø18 PA roller lever with variable length  
IP67



FTNG series	1 function	39 actuator	XXX contact type	XX conduit entry
FTNG 40 mm thermoplastic limit switches for heavy applications	1 without reset function	39 Ø18 PA roller lever with variable length	X11: 1NO+1NC W02: 2NC W20: 2NO Z11: 1NO+1NC Z02: 2NC W12: 1NO+2NC W03: 3NC	blank M20 x 1.5 (standard) N 1/2" NPT G3 PG13.5 C male code "A" M12 x 1 connector

technical drawing - sizes in inches

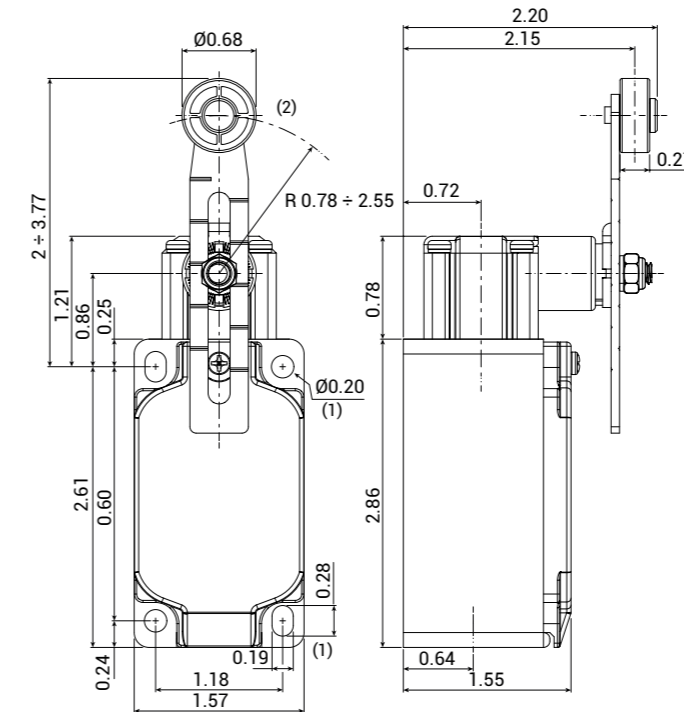

(1) mounting holes

(2) PA roller

contact type	categories	ratings	operational travel		operating force OF	positive opening		total travel TT
			PT1	PT2 (slow action) RP (snap action)		POT (travel)	POF (force)	
X11: 1NO+1NC W02: 2NC W20: 2NO	A600-Q600	AC15: 400V - 4A	33°	45°	6.5 N	45°	8.5 N	80°
Z11: 1NO+1NC Z02: 2NC	B600-Q600	DC13: 24V - 6A	33°	-	6.5 N	45°	8.5 N	
W12: 1NO+2NC W03: 3NC	A300-Q300		33°	-	6.5 N	-	-	
			35°	15°	5.5 N	65°	13.2 N	
			35°	15°	5.5 N	65°	13.2 N	
			35°	42°	6.5 N	50°	8 N	

### FTNG140

Limit switch with Ø50 rubber roller lever with variable length  
IP67



FTNG series		1 function	40 actuator	XXX contact type	XX conduit entry
FTNG	40 mm thermoplastic limit switches for heavy applications	1 without reset function	40 Ø50 rubber roller lever with variable length	X11: 1NO+1NC W02: 2NC W20: 2NO Z11: 1NO+1NC Z02: 2NC W12: 1NO+2NC W03: 3NC	blank M20 × 1.5 (standard) N 1/2" NPT G3 PG13.5 C male code "A" M12 × 1 connector

technical drawing - sizes in inches

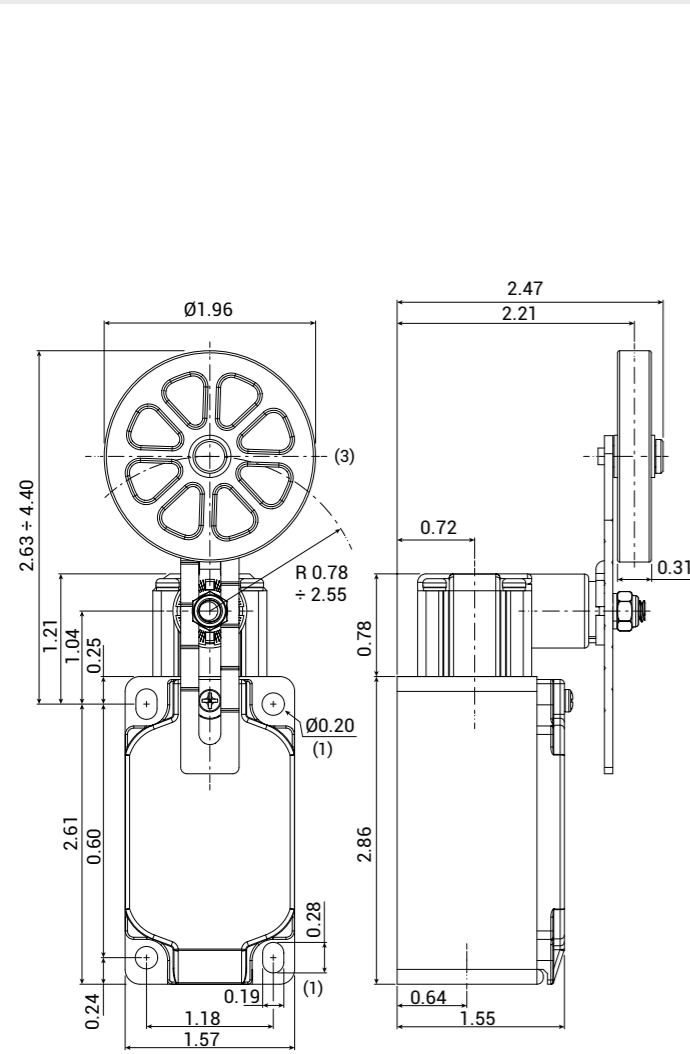

(1) mounting holes  
(3) rubber roller

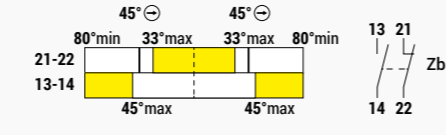
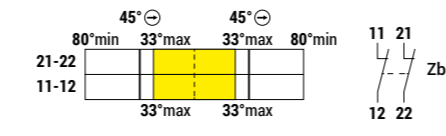
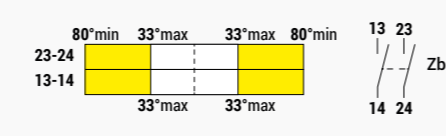
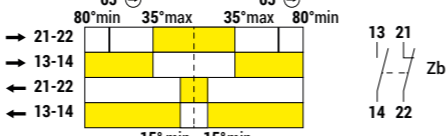
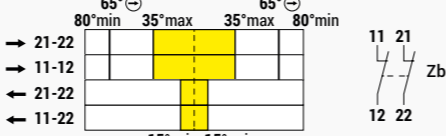
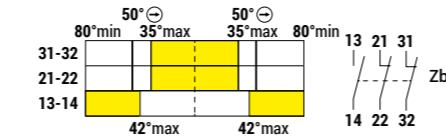
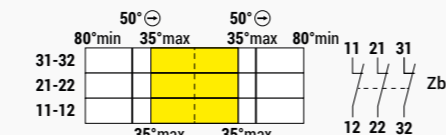
contact type	operation diagrams
X11 1NO+1NC slow action (Zb)	
W02 2NC slow action (Zb)	
W20 2NO slow action (Zb)	
Z11 1NO+1NC snap action (Zb)	
Z02 2NC snap action (Zb)	
W12 1NO+2NC slow action (Zb)	
W03 3NC slow action (Zb)	

### FTNG141

Limit switch with Ø50 rubber roller lever  
IP67



FTNG series		1 function	41 actuator	XXX contact type	XX conduit entry
FTNG	40 mm thermoplastic limit switches for heavy applications	1 without reset function	41 Ø50 rubber roller lever	X11: 1NO+1NC W02: 2NC W20: 2NO Z11: 1NO+1NC Z02: 2NC W12: 1NO+2NC W03: 3NC	blank M20 × 1.5 (standard) N 1/2" NPT G3 PG13.5 C male code "A" M12 × 1 connector

technical drawing - sizes in inches

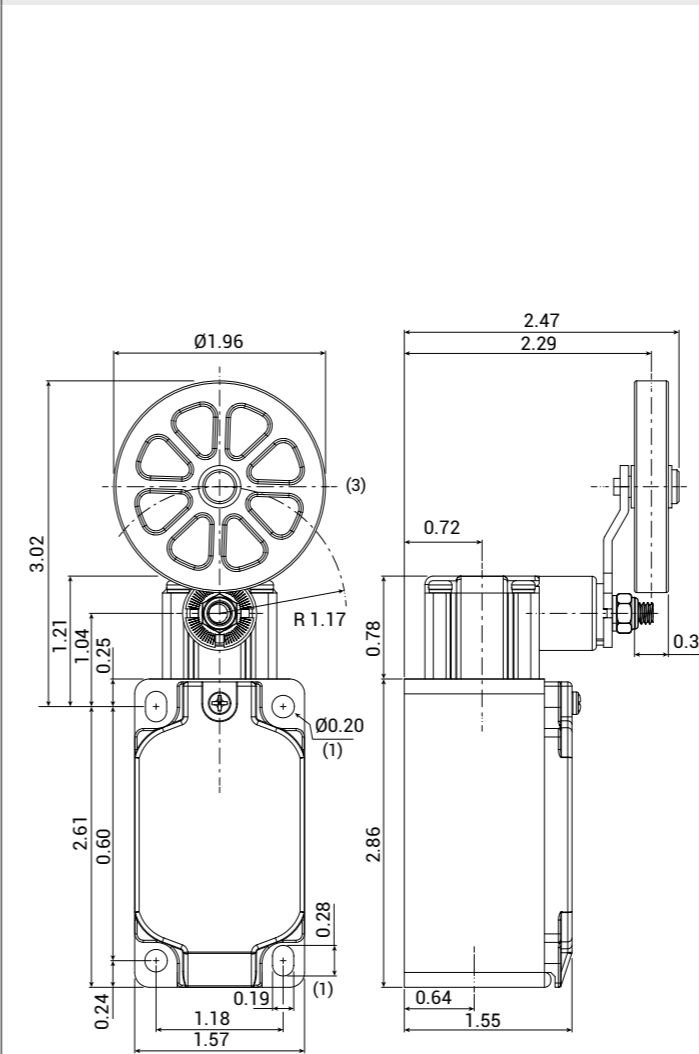

(1) mounting holes  
(3) rubber roller

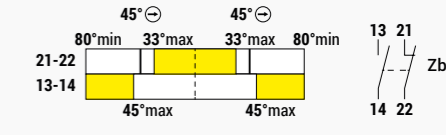
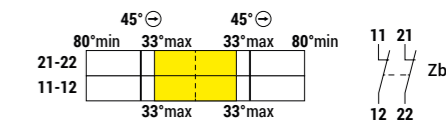
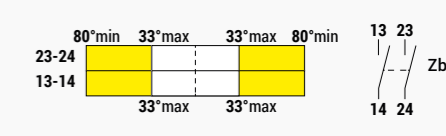
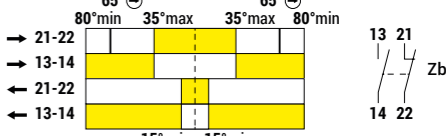
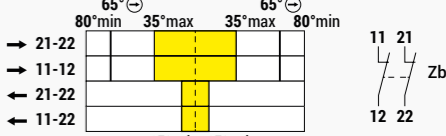
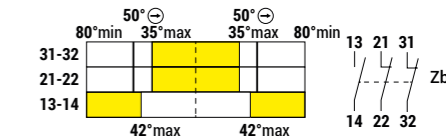
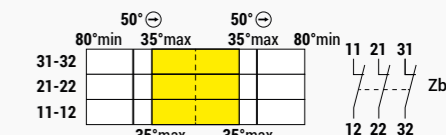
contact type	operation diagrams
X11 1NO+1NC slow action (Zb)	
W02 2NC slow action (Zb)	
W20 2NO slow action (Zb)	
Z11 1NO+1NC snap action (Zb)	
Z02 2NC snap action (Zb)	
W12 1NO+2NC slow action (Zb)	
W03 3NC slow action (Zb)	

contact type	categories	ratings	operational travel		operating force OF	positive opening		total travel TT
			PT1	PT2 (slow action) RP (snap action)		POT (travel)	POF (force)	
X11: 1NO+1NC W02: 2NC W20: 2NO	A600-Q600	AC15: 400V - 4A	33°	45°	6.5 N	45°	8.5 N	80°
Z11: 1NO+1NC Z02: 2NC	B600-Q600	DC13: 24V - 6A	33°	-	6.5 N	-	8.5 N	
W12: 1NO+2NC W03: 3NC	A300-Q300		35°	15°	5.5 N	65°	13.2 N	
			35°	15°	5.5 N	65°	13.2 N	
			35°	42°	6.5 N	50°	8 N	
			35°	-	6.5 N	50°	8 N	

contact type	categories	ratings	operational travel		operating force OF	positive opening		total travel TT
			PT1	PT2 (slow action) RP (snap action)		POT (travel)	POF (force)	
X11: 1NO+1NC W02: 2NC W20: 2NO	A600-Q600	AC15: 400V - 4A	33°	45°	6.5 N	45°	8.5 N	80°
Z11: 1NO+1NC Z02: 2NC	B600-Q600	DC13: 24V - 6A	33°	-	6.5 N	-	8.5 N	
W12: 1NO+2NC W03: 3NC	A300-Q300		35°	15°	5.5 N	65°	13.2 N	
			35°	15°	5.5 N	65°	13.2 N	
			35°	42°	6.5 N	50°	8 N	
			35°	-	6.5 N	50°	8 N	

**SIL<sup>3</sup> READY** **Safety Integrity Level SIL<sup>3</sup>**  
**IEC 61508**

The **Safety Integrity Level (SIL)** is based on the risk reduction value associated with an instrumented safety function that protects against a specific hazardous event, or how the risk must be reduced to an acceptable level.

It is therefore a relative level of risk reduction provided by a safety function and, in other words, provides a measure of the performance of an instrumented safety function.

In **IEC 61508**, safety is defined as “freedom from unacceptable risks of damage”, while risk is the combination of the probability of damage occurring and the severity of such damage. SIL is a measure of reliability and risk reduction used in various international standards.

The reference one for our area of intervention is:

**IEC 61508** (Functional safety of electrical/electronic/programmable electronic/electronic safety systems)

The determination of a SIL is based on quantitative and qualitative factors such as the development process and safety lifecycle management.

**SIL<sup>3</sup> FOR STNK SERIES: thermoplastic safety switch with straight actuator**

**SIL<sup>3</sup> FOR FTN SERIES: thermoplastic limit switches**

**SIL<sup>3</sup> FOR FTNG SERIES: 40 mm thermoplastic limit switches for heavy applications**

Configuration 1oo2 (redundant) 2NC or 2NO or NC + NO positive opening / closing with diagnostics on the two contacts (consistency and crossing check).

$\lambda_{SD}$	$1.79 \cdot 10^{-8}$	$h^{-1}$	$\lambda_s$	$2.18 \cdot 10^{-7}$	$h^{-1}$
$\lambda_{SU}$	$2.00 \cdot 10^{-7}$	$h^{-1}$	$\lambda_D$	$1.20 \cdot 10^{-7}$	$h^{-1}$
$\lambda_{DD}$	0.00	$h^{-1}$			
$\lambda_{DU}$	$1.20 \cdot 10^{-7}$	$h^{-1}$	$\lambda_{TOT}$	$3.39 \cdot 10^{-7}$	$h^{-1}$

**SFF 64.48%**

MTTR 4h

TID0 .0016667 h

TI 12 5 years

PFDv  $5.27 \cdot 10^{-4}$   $1.05 \cdot 10^{-3}$   $2.64 \cdot 10^{-3}$

**SIL3 22**

**STNK SERIES:**  
**thermoplastic safety switch**  
**with straight actuator IP65**



**STNK02**

**FTN SERIES:**  
**thermoplastic limit switches IP67**



**FTN144**

**FTN144S**

**FTNG SERIES:**  
**40 mm thermoplastic limit switches IP67**



**FTNG131**

**FTNG139**



**FTNG140**

**FTNG141**

### MFI - CODE SELECTION OVERVIEW

<b>M</b>	<b>F</b>	<b>I</b>	.			
<b>SERIES</b>		<b>ACTUATOR</b>		<b>TERMINAL TYPE</b>		
MFI micro switches		<b>blank</b> pin plunger <b>1</b> long roller lever <b>2</b> simulated roller lever <b>3</b> roller lever <b>4</b> long lever <b>5</b> medium lever <b>6</b> short lever <b>7</b> 16 mm roller lever		<b>blank</b> 6.3 × 0.8 mm faston <b>S</b> solder <b>ST</b> screw <b>STP</b> screw + plate protection <b>T</b> tower actuator with threaded flange		
				OF [N]	Operating Force	
				RF [N]	Release force	
				PT [mm]	Pretravel	
				OT [mm]	Overtravel	
				MD [mm]	Differential movement	
				OP [mm]	Operating position	

#### Pin plunger

OF	max	5.1 N
RF	min	1.9 N
PT	max	1.4 mm
OT	min	0.8 mm
MD	max	0.3 mm
OP		14.4 ± 0.5 mm

#### Long roller lever

OF	max	3.2 N
RF	min	1.0 N
PT	max	3.3 mm
OT	min	0.8 mm
MD	max	0.8 mm
OP		17.4 ± 0.8 mm

#### Simulated roller lever

OF	max	3.2 N
RF	min	1.0 N
PT	max	3.3 mm
OT	min	0.8 mm
MD	max	0.8 mm
OP		17.4 ± 0.8 mm

#### Roller lever

OF	max	5.1 N
RF	min	1.9 N
PT	max	1.4 mm
OT	min	0.6 mm
MD	max	0.6 mm
OP		20.3 ± 0.8 mm

#### Long lever

OF	max	1.3 N
RF	min	0.15 N
PT	max	7.6 mm
OT	min	2.2 mm
MD	max	2.2 mm
OP		15.1 ± 2.6 mm

#### Medium lever

OF	max	3.2 N
RF	min	1.2 N
PT	max	3.3 mm
OT	min	0.8 mm
MD	max	0.8 mm
OP		15.1 ± 1.2 mm

#### Short lever

OF	max	5.1 N
RF	min	1.9 N
PT	max	1.6 mm
OT	min	0.6 mm
MD	max	0.6 mm
OP		15.1 ± 0.6 mm

#### 16 mm roller lever

OF	max	4.5 N
RF	min	1.9 N
PT	max	1.8 mm
OT	min	0.8 mm
MD	max	0.6 mm
OP		21.1 ± 0.6 mm

#### Tower actuator with threaded flange

OF	max	6.0 N
RF	min	2.0 N
PT	max	2.2 mm
OT	min	3.3 mm
MD	max	0.5 mm
OP		21.2 ± 0.8 mm

(1) Stainless steel lever (2) Plastic material roller (3) Stainless steel roller

**FASTON TERMINALS**      **SOLDER TERMINALS**

**SCREW TERMINALS**      **SCREW TERMINALS + PLATE PROTECTION**

**MAIN SWITCHES**

**IP65**

DESCRIPTION	SERIES	AC-21A 690V	AC-23A 400V	3 POLES CODE
<b>COMPLETE DEVICE in thermoplastic enclosure</b>  • Opening in "0" position. • Arranged for nr. 8 Pg16 cable glands of which nr. 2 on the bottom. • With locking facility in "0 - OFF" (Max 3 locks). • Dimensions: 120x100x85 mm.	SQ025	32 A	25 A	<b>SQ025003BC10</b>
	SQ032	40 A	32 A	<b>SQ032003BC10</b>



For Grey cover and black knob version, replace "10" with "09" in the code.

DESCRIPTION	SERIES	AC-21A 690V	AC-23A 400V	3 POLES CODE
<b>COMPLETE DEVICE in thermoplastic enclosure</b>  • Opening in "0" position. • Arranged with nr. 4 cable glands M25/M32 + nr. 2 closed holes ø22,5 mm on the bottom. • With locking facility in "0 - OFF" (Max 3 locks). • Dimensions: 130x180x106 mm.	SQ040	63 A	50 A	<b>SQ040003BE10</b>
	SQ032	80 A	75 A	<b>SQ063003BE10</b>



For Grey cover and black knob version, replace "10" with "09" in the code.

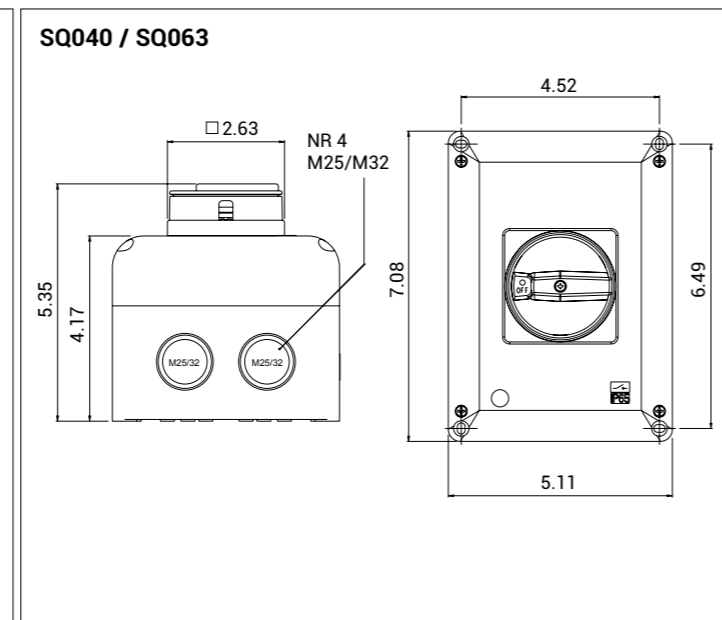
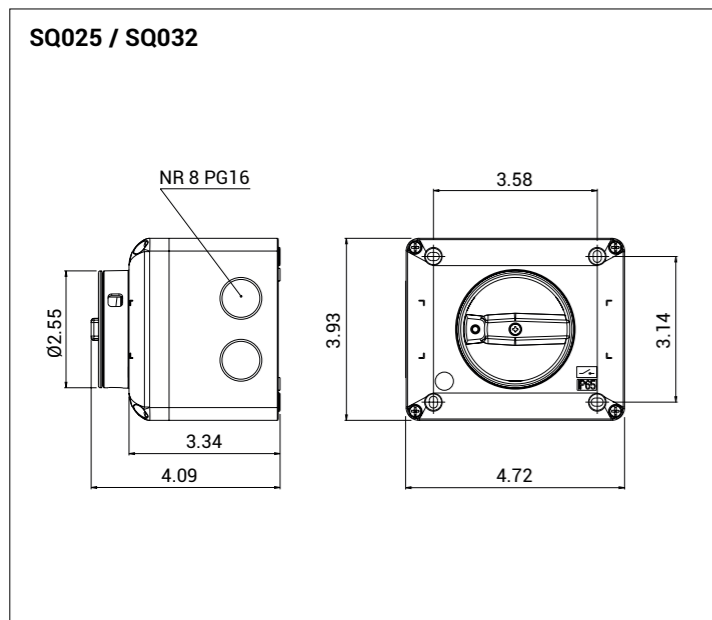

DESCRIPTION	SERIES	AC-21A 690V	AC-23A 400V	2 POLES CODE	3 POLES CODE
<b>BASE MOUNTING with direct command</b>	SQ025	32 A	25 A	<b>SQ025002DL1N</b>	<b>SQ025003DL1N</b>
<b>TYPE D-L1N</b>	SQ032	40 A	32 A	<b>SQ032002DL1N</b>	<b>SQ032003DL1N</b>

- Fixing box DIN RAIL  
DIN-EN 50022-35.
- Black knob locking  
in "0-OFF" position.

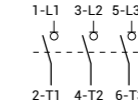
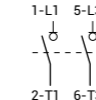

DESCRIPTION	SERIES	AC-21A 690V	AC-23A 400V	2 POLES CODE	3 POLES CODE
<b>BASE MOUNTING with direct command</b>	SQ040	63 A	50 A	<b>SQ040002DL5N</b>	<b>SQ040003DL5N</b>
<b>TYPE D-L5N</b>	SQ063	80 A	75 A	<b>SQ063002DL5N</b>	<b>SQ063003DL5N</b>

- Fixing box DIN RAIL  
DIN-EN 50022-35.
- Black knob locking  
in "0-OFF" position.

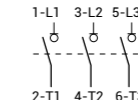
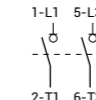

DESCRIPTION	SERIES	AC-21A 690V	AC-23A 400V	3 POLES CODE
<b>BASE MOUNTING</b>	SQN125	125 A	125 A	<b>SQN125003B</b>
<b>TYPE B</b>	SQN160	160 A	160 A	<b>SQN160003B</b>

- Direct command and  
Door Locking.
- Fixing box DIN RAIL  
DIN-EN 50022-35.
- Black knob locking  
in "0-OFF" position.

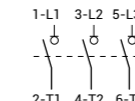

**PANEL BOARD COMPONENTS**

## PUSH BUTTONS Ø0.86 inches IP65

DESCRIPTION	CODE	DESCRIPTION	CODE
ALARM push button flush, yellow colour	PPRN3BL-AL	UP push button flush, white colour	PPRN5BL/F
Lighted ALARM push button flush, yellow colour	PPRL3BL-AL	COMMON push button flush, blue colour	PPRN4BL/COM
Lighted LIGHT push button flush, yellow colour	PPRN3LBL	DOWN push button flush, black colour	PPRN8BL/F
Lighted LIGHT push button flush, black colour	PPRN8LBL	Extended dual push button UP/DOWN	PPDNR.7BL
Extended dual push button UP/DOWN	PPDNR.9ABL	Multifunction push button UP/STOP/DOWN	PPMNSBL.B

## ROTARY SWITCHES Ø0.86 inches IP65



POSITION	WITH OPERATOR		WITH LIGHT OPERATOR		WITH KEY																
	COLOUR INDEX	CODE	COLOUR INDEX	CODE	KEY REMOVAL	CODE															
 90°	■	PSMB1D0BL	■	PSML1D0BL	<table border="1"> <tr><td>L</td><td>O</td><td>R</td></tr> <tr><td>*</td><td></td><td></td></tr> <tr><td></td><td>*</td><td></td></tr> <tr><td>*</td><td>*</td><td>*</td></tr> </table>	L	O	R	*				*		*	*	*	PSCR8D0CBL			
	L	O	R																		
	*																				
		*																			
	*	*	*																		
■	PSMB2D0BL	■	PSML2D0BL	PSCR8D0EBL																	
■	PSMB3D0BL	■	PSML3D0BL	PSCR8D0NBL																	
■	PSMB4D0BL	■	PSML4D0BL																		
■	PSMB5D0BL	■	PSML5D0BL																		
 45°	■	PSMB1D1BL	■	PSML1D1BL	<table border="1"> <tr><td>L</td><td>O</td><td>R</td></tr> <tr><td>*</td><td></td><td></td></tr> <tr><td></td><td>*</td><td></td></tr> <tr><td>*</td><td>*</td><td>*</td></tr> </table>	L	O	R	*				*		*	*	*	PSCR8D1CBL			
	L	O	R																		
	*																				
		*																			
	*	*	*																		
■	PSMB2D1BL	■	PSML2D1BL	PSCR8D1EBL																	
■	PSMB3D1BL	■	PSML3D1BL	PSCR8D1NBL																	
■	PSMB4D1BL	■	PSML4D1BL																		
■	PSMB5D1BL	■	PSML5D1BL																		
 45°	■	PSMB1D2BL	■	PSML1D2BL	<table border="1"> <tr><td>L</td><td>O</td><td>R</td></tr> <tr><td>*</td><td></td><td></td></tr> <tr><td></td><td>*</td><td></td></tr> </table>	L	O	R	*				*		PSCR8D2CBL						
	L	O	R																		
	*																				
		*																			
	■	PSMB2D2BL	■	PSML2D2BL																	
■	PSMB3D2BL	■	PSML3D2BL																		
■	PSMB4D2BL	■	PSML4D2BL																		
■	PSMB5D2BL	■	PSML5D2BL																		
 45°	■	PSMB1T0BL	■	PSML1T0BL	<table border="1"> <tr><td>L</td><td>O</td><td>R</td></tr> <tr><td>*</td><td></td><td></td></tr> <tr><td>*</td><td>*</td><td>*</td></tr> <tr><td>*</td><td>*</td><td>*</td></tr> <tr><td>*</td><td>*</td><td>*</td></tr> </table>	L	O	R	*			*	*	*	*	*	*	*	*	*	PSCR8T0CBL
	L	O	R																		
	*																				
	*	*	*																		
	*	*	*																		
*	*	*																			
■	PSMB2T0BL	■	PSML2T0BL	PSCR8T0ABL																	
■	PSMB3T0BL	■	PSML3T0BL	PSCR8T0EBL																	
■	PSMB4T0BL	■	PSML4T0BL	PSCR8T0GBL																	
■	PSMB5T0BL	■	PSML5T0BL	PSCR8T0HBL																	
 45°	■	PSMB1T3BL	■	PSML1T3BL	<table border="1"> <tr><td>L</td><td>O</td><td>R</td></tr> <tr><td>*</td><td></td><td></td></tr> <tr><td></td><td>*</td><td></td></tr> </table>	L	O	R	*				*		PSCR8T3CBL						
	L	O	R																		
	*																				
		*																			
	■	PSMB2T3BL	■	PSML2T3BL																	
■	PSMB3T3BL	■	PSML3T3BL																		
■	PSMB4T3BL	■	PSML4T3BL																		
■	PSMB5T3BL	■	PSML5T3BL																		
 45°	■	PSMB1T2BL	■	PSML1T2BL	<table border="1"> <tr><td>L</td><td>O</td><td>R</td></tr> <tr><td>*</td><td></td><td></td></tr> <tr><td>*</td><td>*</td><td>*</td></tr> </table>	L	O	R	*			*	*	*	PSCR8T2CBL						
	L	O	R																		
	*																				
	*	*	*																		
	■	PSMB2T2BL	■	PSML2T2BL		PSCR8T2ABL															
■	PSMB3T2BL	■	PSML3T2BL	PSCR8T2HBL																	
■	PSMB4T2BL	■	PSML4T2BL																		
■	PSMB5T2BL	■	PSML5T2BL																		
 45°	■	PSMB1T1BL	■	PSML1T1BL	<table border="1"> <tr><td>L</td><td>O</td><td>R</td></tr> <tr><td>*</td><td></td><td></td></tr> <tr><td></td><td>*</td><td></td></tr> <tr><td>*</td><td>*</td><td>*</td></tr> </table>	L	O	R	*				*		*	*	*	PSCR8T1CBL			
	L	O	R																		
	*																				
		*																			
	*	*	*																		
■	PSMB2T1BL	■	PSML2T1BL	PSCR8T1EBL																	
■	PSMB3T1BL	■	PSML3T1BL	PSCR8T1NBL																	
■	PSMB4T1BL	■	PSML4T1BL																		
■	PSMB5T1BL	■	PSML5T1BL																		

■ For standard rotary switches suitable to operate a central contact, replace the letter "B" with the letter "C": PSMB1C0 or PSCR8SDE  
 ■ For rotary switches with Left - Right operating angles replace the letters "DO" with "SD": PSMB1DO or PSCR8SDE

\* Key removable position

NOTE: Dimensions of technical drawings are in inches





**GIOVENZANA**  
INTERNATIONAL B.V.



[www.giovenzana.com](http://www.giovenzana.com)

Discover online our complete range of ELEVATOR SAFETY SOLUTIONS

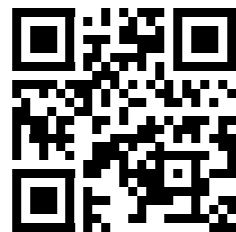

Download the  
TECHNICAL DOCUMENTATION



**GIOVENZANA**  
INTERNATIONAL B.V.

Follow us!

# ELEVATOR SAFETY SOLUTIONS

Giovenzana International B.V. has been providing innovative elevator electrical components for over 65 years. Today we are recognized as a world leader in control, interface, safety and wiring products as a preferred supplier to every global elevator company.

The growing portfolio of high quality elevator products includes:

- Top of car inspection boxes;
- Emergency stops;
- Safety pull out switches;
- Limit switches;
- And much More!!!

Whether you are looking for solutions to new elevator designs, Giovenzana International has the experience, knowhow and solutions to meet your needs!

**SIL<sup>3</sup> READY**



Products according to ASME A17.1-2019/CSA B44:2019

[www.giovenzana.com](http://www.giovenzana.com) - [giovenzana@giovenzana.com](mailto:giovenzana@giovenzana.com)

**GIOVENZANA INTERNATIONAL B.V.**

Amsterdam, **THE NETHERLANDS**  
Ph: +31 (0) 20.4413576  
E-mail: [giovenzana@giovenzana.com](mailto:giovenzana@giovenzana.com)

**G.T.R. LLC**

Moscow, **RUSSIAN FEDERATION**  
Ph: +7.499.9228548  
E-mail: [gtr@giovenzana.com](mailto:gtr@giovenzana.com)

**GIOVENZANA CONTROLS INDIA Pvt. Ltd.**

Mumbai, **INDIA**  
Ph: +91.22.42640071  
E-mail: [ggindia@giovenzana.com](mailto:ggindia@giovenzana.com)

**GIOVENZANA CONNECTING BRASIL LTDA**

Guafba, Rio Grande do Sul, **BRASIL**  
Ph: (+55) 51 3055 1033  
E-mail: [gcb@giovenzana.com](mailto:gcb@giovenzana.com)

**GIOVENZANA INTERNATIONAL B.V. - Dubai Branch**

Dubai, **U.A.E.**  
Ph: +971.4.8870788  
E-mail: [uae@giovenzana.com](mailto:uae@giovenzana.com)

**WWW.GIOVENZANA.COM**

